

ANSCHÜTZ

EINFACH EINS WERDEN!

USER MANUAL

Model

9015



J.G. ANSCHÜTZ GmbH & Co. KG

Jagd- und Sportwaffenfabrik

Daimlerstraße 12 · 89079 Ulm / Germany | Fon +49 - (0)731 - 40 12 - 0 | Fax +49 - (0)731 - 40 12 - 700

www.anschuetz-sport.com | www.facebook.com/OfficialAnschuetz | www.youtube.com/AnschuetzGmbH | www.instagram.com/AnschuetzGmbH

Version 10 | 10 | 2022

Inhaltsverzeichnis

| | | | | | |
|---|-----------|---|-----------|--|-----------|
| 1. Components/Terminology | 3 | 13. Converting the cocking lever | 14 | 19. Stock adjustments | 23 |
| 2. Introduction | 4 | 13.1 Conversion from right to left | 14 | 19.1 Fore-end raiser block | 23 |
| 3. Key to Symbols | 4 | 14. Trigger | 14 | 19.2 Offsetting the stock | 23 |
| 3.1 General instructions | 4 | 14.1 Trigger weight | 15 | 19.3 Grip adjustment | 24 |
| 3.2 Safety instructions | 4 | 14.2 First stage pull (only with two-stage trigger) | 15 | 19.4 Removing stock and grip | 24 |
| 4. General handling of firearms | 5 | 14.3 Sear engagement | 15 | 20. Optical sights/rear sight (option) | 24 |
| 4.1 Important basics | 5 | 14.4 First stage travel (only with two-stage trigger) | 16 | 20.1 Mounting | 24 |
| 4.2 Shooting | 6 | 14.5 Trigger stop | 16 | 20.2 Elevation and windage adjustment | 24 |
| 4.3 Maintenance | 6 | 14.6 Adjusting the trigger blade. | 16 | 20.3 Zero adjustment | 24 |
| 4.4 Transport | 6 | 14.7 Conversion two-stage trigger to single stage trigger | 16 | 21. Maintenance/cleaning | 25 |
| 4.5 Storage. | 7 | 14.8 Conversion single stage trigger to two-stage trigger | 16 | 21.1 General | 25 |
| 4.6 Hearing and eye protection | 7 | 14.9 Trigger faults caused by incorrect adjustment | 17 | 21.2 Maintenance intervals | 26 |
| 5. General handling of compressed air cylinders. | 7 | 14.10 Basic adjustment of the trigger | 17 | 21.3 Trigger maintenance. | 26 |
| 6. Safety flag | 9 | 15. Dry firing device | 17 | 21.4 Maintenance of the optical sights. | 27 |
| 7. Legal | 10 | 16. Compressed air cylinder | 18 | 22. Troubleshooting. | 27 |
| 8. Intended use | 10 | 16.1 Screwing the compressed air cylinder in | 19 | 23. Technical Data (depending on model) | 27 |
| 9. Liability | 10 | 16.2 Releasing the compressed air cylinder | 19 | 24. Disposal | 27 |
| 10. Before using for the first time | 11 | 16.3 Filling the compressed air cylinder | 19 | 25. Miscellaneous | 27 |
| 11. Removing / Installation of the barreled action 11 | 11 | 17. Cheek piece | 21 | 26. Shooting Performance | 28 |
| 11.1 Removing the barreled action | 11 | 17.1 Removing the cheek piece | 21 | 27. Warranty | 28 |
| 11.2 Fitting the barreled action | 12 | 17.2 Adjusting the cheek piece | 21 | | |
| 12. Cocking, loading, setting the safety, releasing 12 | 12 | 18. Butt plate | 22 | | |
| 12.1 Cocking. | 12 | 18.1 Removing the butt plate | 22 | | |
| 12.2 Loading | 12 | 18.2 Adjusting the butt plate. | 22 | | |
| 12.3 Engaging the safety catch | 13 | 18.3 Adjusting the butt plate for 3-position shooting | 22 | | |
| 12.4 Releasing the safety catch | 13 | 18.4 Adjustment possibilities for the butt plate | 22 | | |
| | | 18.5 Stock carrier | 23 | | |
| | | 18.6 Length adjustment of the stock | 23 | | |

1. Components/Terminology

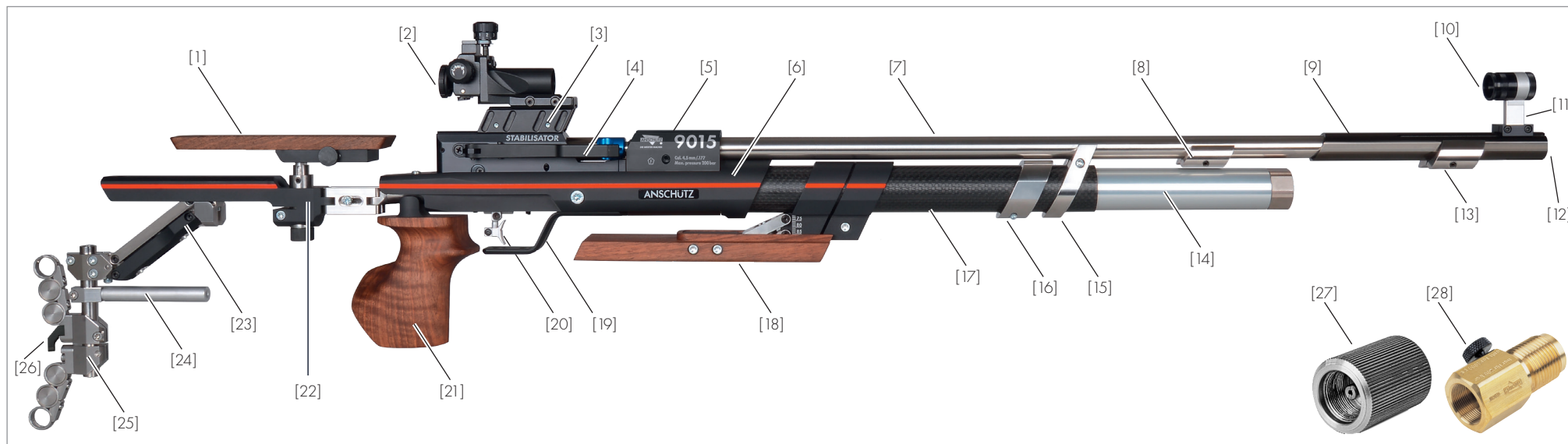

Fig. 1 Overall view using 9015 in stock ONE

| | | | |
|----------------------------|---|----------------------------|------------------------|
| [1] Cheek piece | [10] Front sight | [18] Fore-end raiser block | [27] Air release screw |
| [2] Rear sight | [11] Front sight riser block* | [19] Trigger guard | [28] Refilling adapter |
| [3] Rear sight riser block | [12] Visible muzzle | [20] Trigger | |
| [4] Cocking lever | [13] Clamping weight sight line extension | [21] Grip | |
| [5] Assembly carrier | [14] Compressed air cylinder | [22] Back end | |
| [6] Fore-end | [15] Barrel ring | [23] Back end carrier | |
| [7] Barrel | [16] Stock weight | [24] Feedback rod | |
| [8] Clamping weight barrel | [17] Fore-end tube | [25] Butt plate | |
| [9] Sight line extension | | [26] ONE-Spacer | |

* The front sight riser block „Bridge 16 mm“ [11] fits only to CENTRA front sight M18. When using a CENTRA front sight M22, please use the front sight riser block XXL, which is included in the accessory box of your rifle.

NOTE: Your rifle may differ from the product image shown as it varies by model and features.

2. Introduction

Dear ANSCHÜTZ Customer,

Thank you for choosing an ANSCHÜTZ product. Many spectacular sporting successes have been achieved by marksmen, olympians and shooters in world and European championships using ANSCHÜTZ sporting rifles.

ANSCHÜTZ hunting and sporting rifles are highly reputed as a result of their well-engineered design, workmanship and outstanding shooting performance. Quality and precision are a part of our tradition, and have grown as a result of our experience since 1856.

We wish you much pleasure and sporting success with your new ANSCHÜTZ product.

Your ANSCHÜTZ team

3. Key to Symbols



In this handbook, the following symbols are used to distinguish between general information and particularly important information:

3.1 General instructions

- ▶ is the symbol for an instruction
- ✓ shows the desired result
- ☞ is the symbol for a list item
- is the symbol for a possible handling consequence

3.2 Safety instructions

⚠ identifies a safety instruction.

| | |
|---|--|
|  | <p>NOTE!</p> <p>An instruction indicating a specific course of action.</p> |
|  | <p>CAUTION!</p> <p>Indicates a hazardous situation that can lead to minor physical injury or material damage.</p> |
|  | <p>WARNING!</p> <p>Indicates a hazardous situation that can lead to serious physical injury or death.</p> |

4. General handling of firearms

Firearms are dangerous objects requiring the utmost care in their storage and use. The following safety and warning instructions must be observed without exception!

| | |
|---|---|
|  | NOTE! |
| | <p>The firearms legislation of the relevant country must be respected and complied with.</p> |

4.1 Important basics

| | |
|---|---|
|  | NOTE! |
| | <p>The use of firearms while under the influence of drugs, alcohol or medication is not permitted. Vision, dexterity and judgement can all be adversely affected.</p> <p>A good physical and mental constitution is a prerequisite for using a firearm.</p> |

- ⚠ *A firearm must only ever be used for its designated purpose.*
- ⚠ *Firearms owners are responsible for ensuring that their firearm is at no time, and especially when absent, within reach of or accessible to children or other unauthorised persons.*
- ⚠ *Firearms must not be handed over to unauthorised persons.*
- ⚠ *Modifications to the rifle and the use of non-genuine ANSCHÜTZ accessories can lead to malfunctions.*
- ⚠ *Serious or life-threatening injuries and damage can be caused by the use of incorrect ammunition, by contamination in the barrel or by incorrect cylinder components.*
- ⚠ *Weapons modified in a way that could affect safety must not be used. If a fault or malfunction is detected, the weapon must be unloaded and taken to an authorised gunsmith for repair.*
- ⚠ *In the event of external effects (e.g. corrosion, being dropped, etc.), the weapon must be checked by an authorised gunsmith.*
- ⚠ *A weapon must always be treated with the utmost care and be protected from accidental damage.*

4.2 Shooting

| | |
|---|---|
|  | WARNING! |
| | <p>Danger to life and causing material damage! Aiming the rifle at people and objects.</p> <ul style="list-style-type: none"> ▶ When the rifle is not in use, keep the muzzle pointing in a safe direction. ▶ The muzzle of a firearm must never be held in a direction where it can cause damage or endanger life.. |

| | |
|---|---|
|  | WARNING! |
| | <p>Malfunction when shooting! Shot not discharged after trigger pulled.</p> <ul style="list-style-type: none"> ▶ Do not look down into the muzzle. ▶ Keep the muzzle of the firearm pointing in a safe direction. ▶ Unload the firearm. ▶ Remove residues from the barrel. |

- ⚠ *Any firearm must be treated as if it were loaded.*
- ⚠ *Never pick up a firearm by the trigger.*
- ⚠ *Shooting galleries must be adequately ventilated.*
- ⚠ *Any bullet trap in the shooting gallery must be completely safe and visible.*
- ⚠ *No persons may stand in the vicinity of the target during a shoot.*
- ⚠ *Firearms should not be used when visibility is poor.*
- ⚠ *Do not shoot into the air, at hard or smooth surfaces, at water or at targets on the horizon.*

- ⚠ *Do not shoot at targets if the shot could ricochet or be deflected in a dangerous manner.*
- ⚠ *To prevent accidents or damage to your rifle, never discharge a shot with the muzzle held under water or up against materials or objects.*
- ⚠ *Only shoot using the calibre specified on the barrel of the rifle.*
- ⚠ *Only new, clean, factory-charged ammunition of the calibre permitted for the rifle may be used.*
- ⚠ *The ammunition must conform to the specifications of the C.I.P.*
- ⚠ *Only ever load the rifle immediately before use.*
- ⚠ *Life-threatening injuries and material damage can be caused by the use of incorrect ammunition, contamination in the barrel or incorrect cylinder components.*
- ⚠ *Only genuine ANSCHÜTZ parts may be used.*

4.3 Maintenance

- ⚠ *Ensure that the rifle is unloaded before and after use or during maintenance and cleaning.*

4.4 Transport

- ⚠ *Firearms may only be transported in an unloaded condition and in locked containers.*
- ⚠ *When you are putting your rifle in a case or a soft case, always make sure that the rifle and the inside of the case or soft case are dry and that no water or moisture remains.*
- ⚠ *Only ever put a cleaned, dry and oiled rifle in your case or soft case.*
- ⚠ *Always place the rifle in the transport case with the sight facing upwards (towards the handle). This protects the rear sight from impacts and also protects the rear sight setting screws as a result.*

4.5 Storage

- ⚠️ *Firearms that are not in use must be kept in a secure place under lock and key.*
- ⚠️ *Firearms must always be stored in an unloaded and uncocked condition.*
- ⚠️ *Ammunition must be kept in a separate place under lock and key.*

4.6 Hearing and eye protection

| | |
|---|---|
|  | NOTE! |
| | For your own safety, approved hearing and eye protection should be used when shooting! Shooting without safety equipment can result in damage to your hearing and sight. |

5. General handling of compressed air cylinders

The high-quality ANSCHÜTZ compressed air cylinders are produced using a very elaborate manufacturing process that includes strict checks and tests during production. The compressed air cylinders are also subject to a type approval guideline and are certificated accordingly. TÜV Rhineland constantly monitors compliance with these stipulations. We employ this expensive and complicated manufacturing process in order to provide you, the customer and user, with the maximum possible safety when handling and using the compressed air cylinders.

For this reason we would ask you to observe the following safety rules when handling the compressed air cylinders.







| | |
|---|--|
|  | NOTE! |
| | When using compressed air cylinders please always observe the instructions of ANSCHÜTZ! |

- ⚠️ *The fill level indicator of the compressed air cylinder may only be checked when the compressed air rifle is unloaded and uncocked.*
- ⚠️ *The fill level indicator of the compressed air cylinder must not be checked during re-filling.*

| | |
|---|---|
|  | NOTE! |
| | Design aspects mean that the fill level indicator operates with an accuracy of $\pm 10\%$. Temperature influences mean that there can also be deviations in the fill level indicator. |

- ⚠️ *Full compressed air cylinders must not be exposed to temperatures below -20°C or above 70°C (when transporting and storing them, adequate insulation must be provided, e.g. by storing in expanded polystyrene packaging or in a gun case).*
- ⚠️ *In aircraft, when sending by post, etc. the compressed air cylinders must always be unfilled.*
- ⚠️ *After approx. 20 fillings, the compressed air cylinder must be emptied slowly and completely in order to allow any condensed water to escape.*
- ⚠️ *When screwing on or off the compressed air cylinder or when refilling it, always stand side on in relation to the cylinder and ensure that no other person is in the vicinity of the end of the cylinder (where the manometer is positioned).*
- ⚠️ *Shocks and blows can lead to defects in the pressure gauge or the cartridge.*



| | |
|---|--|
|  | NOTE! |
| | ANSCHÜTZ recommends the use of an air release screw from the ANSCHÜTZ range of accessories (Item No.: 016623) for emptying the compressed air cylinder. |

-  *The compressed air cylinder must be checked for cracks and damage before each use.*
-  *Compressed air cylinders which are defective, have leaks or which are damaged must be safely depressurized. They may no longer be used or filled and must be replaced immediately.*
-  *Compressed air cylinders must not be used for longer than 10 years.*
-  *After 10 years (from the date of manufacture) the compressed air cylinders must be safely emptied in accordance with the manual (see Chapter 17) and must not be used or filled any more (the date of manufacture is marked on the compressed air cylinder).*
-  *The surface of the compressed air cylinder must not be tampered with.*
-  *In particular, you must not carry out any engraving or other abrasive processes because this could lead to damage to the pressurised container and thus present a safety hazard.*
-  *Compressed air cylinders and the refilling adapter must be stored in a secure, dry, grease-free and dust-free location.*

| | |
|---|---|
|  | NOTE! |
| | The refilling adapter is also fitted with an air filter to protect from dirt and dust particles. |

-  *After unscrewing the compressed air cylinder, the cylinder thread must be kept clean and the relevant protective cap must be fitted.*

| | |
|---|--|
|  | NOTE! |
| | Self monitoring! |
| | The marksman is responsible for compliance with the regulations and stipulations contained in the ANSCHÜTZ user's handbook. |
| ANSCHÜTZ accepts no liability for damage of any kind caused by modification of parts, conversion, repair or fitting of non-genuine ANSCHÜTZ parts or by non-compliance with the user's manual. | |

| | |
|---|--|
|  | WARNING! |
| | <p>Danger of explosion! Explosion danger from oiled air entry valve and thread.</p> <ul style="list-style-type: none">  The air entry valve and thread on the compressed air cylinder should only be lightly greased using genuine ANSCHÜTZ grease (special grease 4425, Item No.: 001489). |

| | |
|---|---|
|  | WARNING! |
| | <p>USE only genuine ANSCHÜTZ compressed air cylinders (max. 200 bar) with type approval! If you use non-genuine ANSCHÜTZ compressed air cylinders, the liability and guarantee entitlement for the compressed air cylinder and the rifle will become void (we refer here to section 16 of this user manual).</p> |

⚠ *The maximum filling pressure for compressed air cylinders is 200 bar at room temperature.*

6. Safety flag

| | |
|---|---|
|  | WARNING! |
| | <p>Danger of explosion! Overfilled compressed air cylinder.</p> <p>▶ The maximum filling pressure of 200 bar at room temperature must not be exceeded.</p> |

- ⚠ *When filling the compressed air cylinder, the compressed air must not contain oil, water or any other contaminant (DIN EN 12021 - breathing air).*
- ⚠ *ANSCHÜTZ supplies compressed air cylinders unfilled, in accordance with the safety regulations.*
- ⚠ *ANSCHÜTZ recommends that compressed air cylinders be always transported empty.*
- ⚠ *Compressed air cylinders must never be opened, disassembled, repaired or mechanically modified.*
- ⚠ *The compressed air cylinder must be protected from forceful impacts.*
- ⚠ *Compressed air cylinders are not intended for the transport of gases of any kind.*



| | |
|---|---|
|  | CAUTION! |
| | <p>Malfunction and missing action pressure! Bent loading mechanism caused by incorrect handling.</p> <p>▶ Never close the action if the safety flag is inserted.</p> |

| | |
|---|--|
|  | NOTE! |
| | <p>When filling, transporting and handling (including for commercial use) you must follow the "Compressed Gases Technical Regulations (TRG) or the legal stipulations applicable in the individual country concerned.</p> |

7. Legal



NOTE!

The applicable firearms legislation, regulations and provisions for the relevant country, and also the safety rules of the hunting and sporting organisations must be observed.

8. Intended use

The ANSCHÜTZ compressed air model 9015 is a compressed air rifles. They are exclusively for use on ranges (for sports disciplines) and must be used exclusively by persons with the relevant firearms permit.

The use is subject exclusively to the „General Technical Regulations“ for all shooting sports disciplines of the INTERNATIONAL SHOOTING SPORT FEDERATION (ISSF) or the regulations of the INTERNATIONAL BIATHLON UNION, E-Mail: biathlon@ibu.at.



NOTE!

A firearm must only ever be used for its designated purpose.

9. Liability

ANSCHÜTZ will accept no liability or claims for compensation for damage of any kind arising from:

- failure to comply with the instructions in this user's handbook,
- improper treatment, repair or disassembly,
- use of non-genuine ANSCHÜTZ parts,
- use of non-original ANSCHÜTZ compressed air cylinder,
- incorrect handling or care,
- negligence,
- removal of the sealing lacquer,
- unauthorised tampering or
- transport damage.



CAUTION!

Modifications to or tampering with the rifle or its parts are forbidden and may possibly infringe the guarantee conditions. Alterations of this kind can have an adverse effect on the safe use of the product and lead to accidents that endanger life and limb. In such cases the guarantee is automatically void.

 *The rifle must be examined for any changes each time before use.*

10. Before using for the first time



NOTE!

For safety reasons, check the action fixing each time before you shoot.

- ▶ Wipe off any excess oil from the surface of the barreled action.
- ▶ Cleaning cord with cotton wicks (Cleaning Kit 507, Item No.: 001491) to be pulled through the barrel from the chamber towards the muzzle.



NOTE!

The air rifle is designed for shooting at room temperature. At low temperatures (particularly at temperatures below zero Celsius) the air rifle must be brought to room temperature before shooting.

We do not recommend use below 0° C, for physical reasons and reasons of precision technology.

11. Removing / Installation of the barreled action

11.1 Removing the barreled action

- ▶ Remove the compressed air cylinder [14] (see Chapter 16.2).
- ▶ Loosen the screw [a] on the barrel ring [15].
- ▶ Remove the screws [b] on both sides of the fore-end [6].
- ▶ Remove the barreled action upwards.

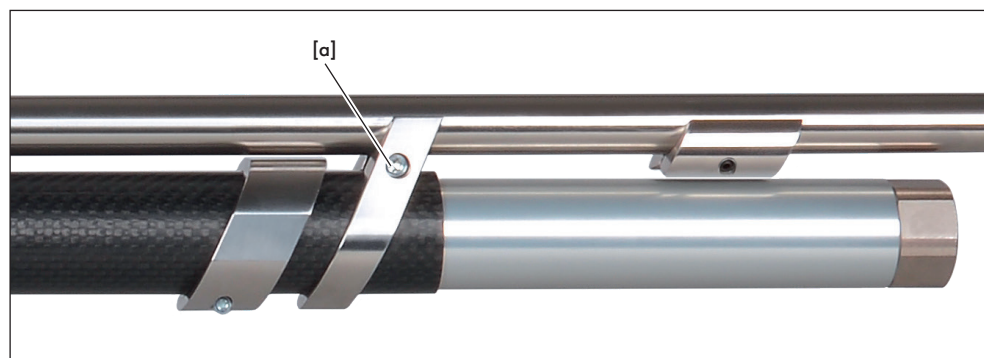

Fig. 2 Loosen screw on the barrel ring

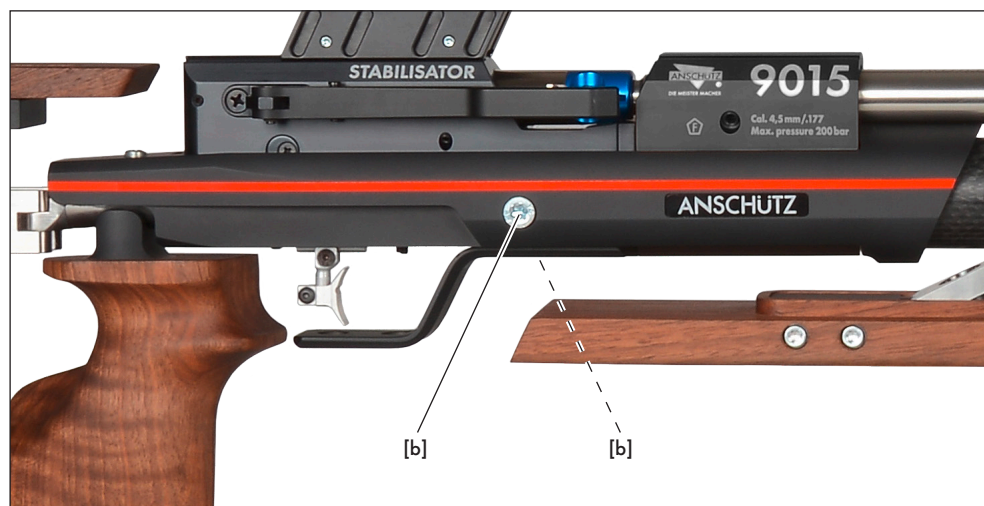

Fig. 3 Remove the screws on both sides of the fore-end

11.2 Fitting the barreled action

- ▶ Insert the barreled action.
- ▶ First, slightly tighten the screws [b] on the fore-end [6].
- ▶ Tighten the screw [a] (torque 1.8 Nm) on the barrel ring [15].
- ▶ Position the rifle vertically (butt plate downwards).
- ▶ Tighten the screw [b] (torque 5 Nm) on both sides of the fore-end [6].
- ▶ Screw down the compressed air cylinder [14] (see Chapter 16.1).

12. Cocking, loading, setting the safety, releasing

12.1 Cocking

- ▶ In order to tension the cocking piston, slowly pull the cocking lever [4] (in the direction of the arrow) until it is noticeably in position.

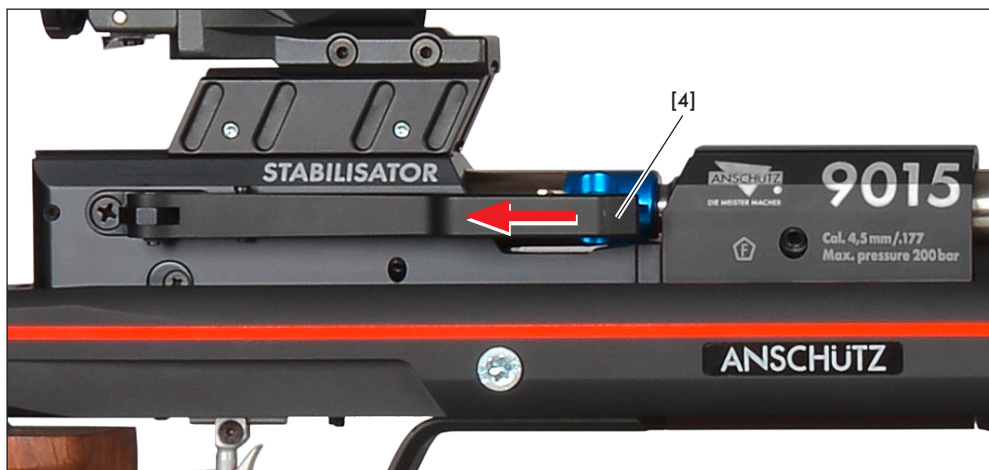

Fig. 4 Cocking the rifle

- ✓ The action opens and the opening to the barrel is revealed.

12.2 Loading

| | |
|--|---|
| | CAUTION! |
| | <p>Malfunction and danger of injury! Use of non-permitted ammunition and foreign objects.</p> <ul style="list-style-type: none"> ▶ Use only the calibre permitted for use with the firearm. |

- ▶ To load, slide the lead Diabolo (with the flat end [A] facing forwards) into the chamber until it is flush.
- ▶ Lock the action by slowly closing the cocking lever [4].
- ✓ The action is locked.
- ✓ The rifle is now ready to shoot (loaded and cocked) (provided that the compressed air cylinder is full).



Fig. 5 Diabolo (shown enlarged)

- ⚠ **Unloading is carried out by shooting a pellet into the bullet trap.**

12.3 Engaging the safety catch

► Push the safety catch [x] in backwards (in the direction of the arrow).

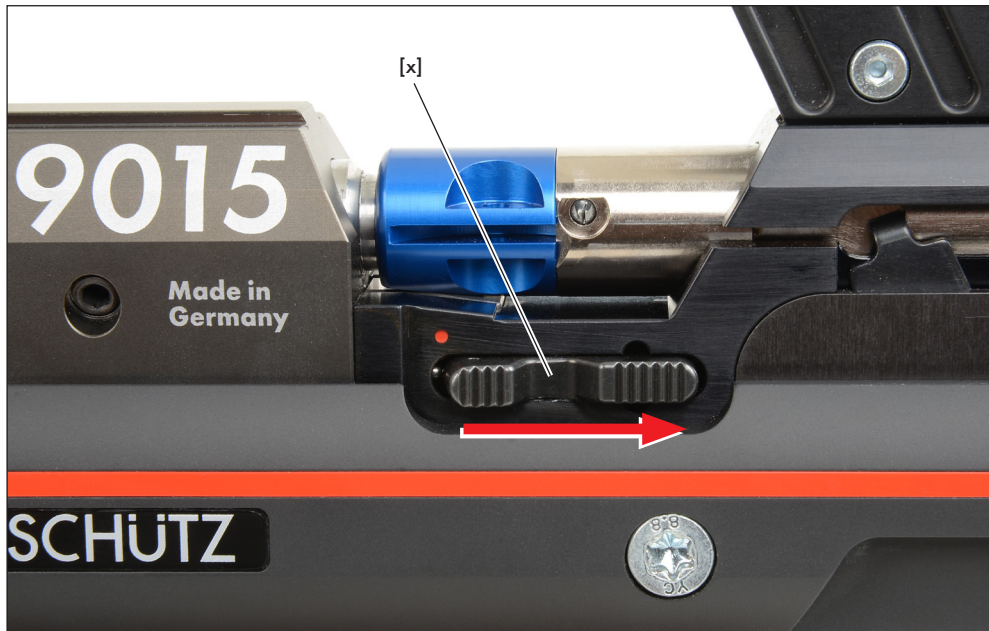

Fig.6 Safety catch „Safe“

✓ The rifle is cocked and the safety catch is engaged.



NOTE!
The safety catch must engage exactly and audibly and must not sit between the end stops. The firearm can only be engaged/released when the rifle is cocked.

12.4 Releasing the safety catch

► Push the safety catch [x] in forwards (in the direction of the arrow, towards „red dot“).

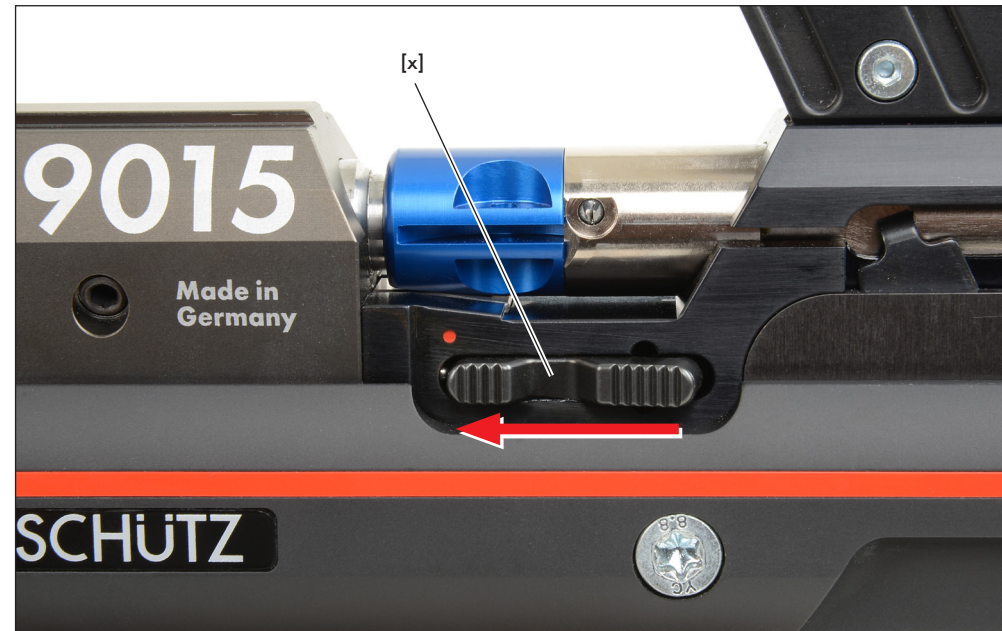

Fig.7 Safety catch „Ready to Fire“

✓ The rifle is cocked and the safety catch is released.



CAUTION!
After actuating the trigger in the safe condition (dry firing), the firearm must be re-cocked to release it. Forcible changeover of the safety can lead to damage and inadvertent discharge of a shot.

13. Converting the cocking lever

13.1 Conversion from right to left

- ▶ Remove circlip [a] from the pin [b].
- ▶ Remove pin [b].
- ▶ Release set screws [c] (Torque 1.8 Nm).
- ▶ Remove the complete cocking lever assembly [d] and re-fit on the opposite side in reverse order.

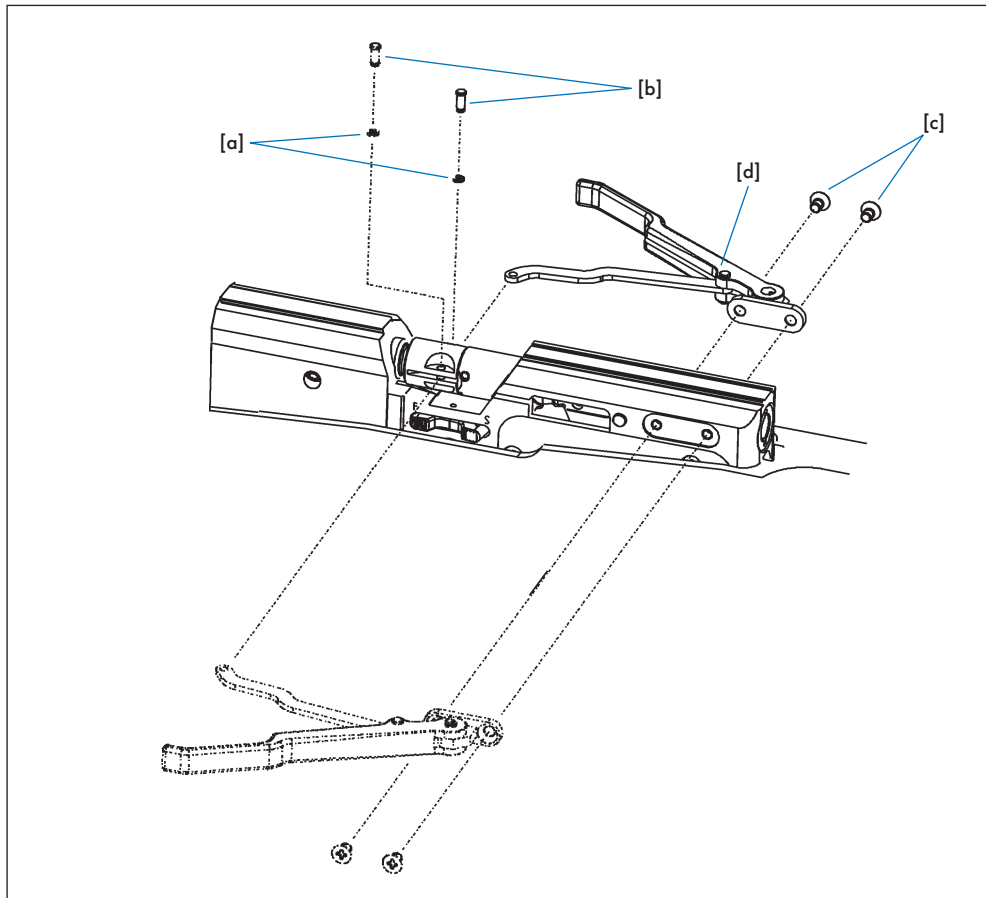

Fig. 8 Converting the cocking lever [4]

14. Trigger

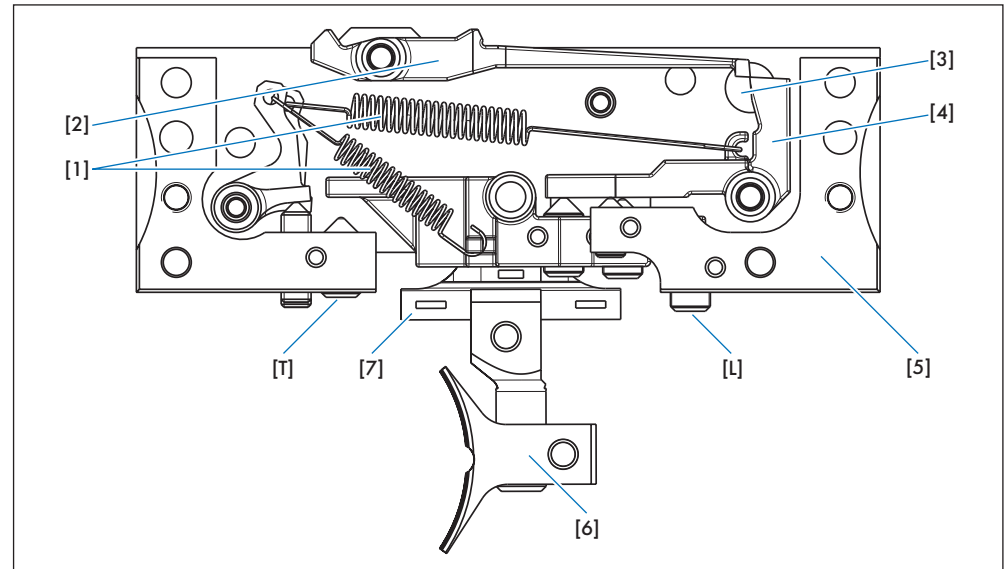

Fig. 9 Trigger 5065 4K (side view)

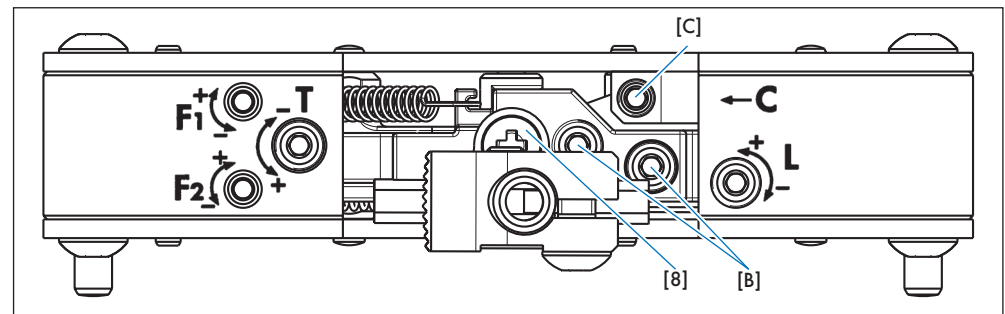

Fig. 10 Trigger 5065 4K (view from below)

Key (to Figs. 9+10)

- | | | | |
|---|-----------------|-----|------------------------------|
| 1 | Tension spring | 7 | Trigger sear |
| 2 | Catch link | 8 | Trigger sear clamping screw |
| 3 | Viewing window | F1 | Weight of first stage |
| 4 | Release catch | F2 | Trigger weight |
| 5 | Trigger housing | T | Trigger stop |
| 6 | Trigger blade | L | First stage travel |
| | | B+C | Basic factory setting/sealed |

**WARNING!****Danger to life!**

Danger to life from loaded firearm.

- ▶ Make sure that the rifle is unloaded when carrying out alignment and adjustment procedures.

**NOTE!**

The trigger on Model 5065 4K is delivered with the following factory setting:

Two-stage trigger with approx. 100 g set trigger weight.

**NOTE!**

The setting screws B and C are pre-set and sealed in the factory. Setting or modification using these screws is prohibited.

14.1 Trigger weight

Setting the trigger weight using the setting screw F2 (setting range from 50 g to 170 g):

- turn clockwise = trigger weight is increased (+)
- turn anticlockwise = trigger weight is reduced (–)

14.2 First stage pull (only with two-stage trigger)

Setting the first stage pull using the setting screw F1:

- turn clockwise = first stage weight is increased (+)
- turn anticlockwise = first stage weight is reduced (–)

14.3 Sear engagement

The sear engagement denotes the travel from the second stage to the release of the trigger. The sear engagement is set in the factory to an optimum value.

**WARNING!****Danger to life!**

Unintentional discharge as a result of too short a sear engagement and/or too low a trigger weight.

- ▶ Do not set the sear engagement too short.
- ▶ Do not set the trigger weight too low.
- ▶ Do not subject loaded and unsecured rifles to impact and do not use force to close the breech.

14.4 First stage travel (only with two-stage trigger)

First stage travel denotes the travel of the trigger blade from the zero position to the second stage.

Setting the first stage travel using setting screw [L]:

- turn clockwise = first stage travel is shortened
- turn anticlockwise = first stage travel is lengthened

14.5 Trigger stop

The trigger stop denotes the travel from the second stage to the end stop for the trigger blade.

Setting the trigger stop using the trigger stop setting screw [T]:

- turn clockwise = trigger stop is shortened
- turn anticlockwise = trigger stop is lengthened

| | |
|--|--|
|  | CAUTION! |
| | <p>Malfunction! Trigger stop setting screw is screwed in beyond the second stage or direct function (trigger will not actuate).</p> <p>▶ Trigger stop adjustment screw should not be screwed in beyond the second stage or direct function.</p> |

14.6 Adjusting the trigger blade

Release the relevant clamping screw (according to required setting). The trigger blade can be moved along the guide, swung to the side and adjusted in height. The trigger blade can be removed completely and turned through 180°. The longer part of the trigger blade now points downwards. The blade holder is asymmetric and can be fitted offset by 180° to provide additional length adjustment. The lateral blade adjustment can also be varied in the same way. By releasing the screw (8), the trigger sear can be turned through 180° to permit offset to the side. After adjusting the desired setting of the trigger shoe, tighten the clamping screw (torque 1 Nm).

14.7 Conversion two-stage trigger to single stage trigger

Adjustment using setting screw [L]. Turn the setting screw [L] to the right until there is no more first stage travel.

| | |
|--|---|
|  | WARNING! |
| | <p>Danger of injury by automatic firing! Automatic firing and malfunction caused by minimum setting of trigger weight, first stage travel too small or the sear engagement is too small.</p> <p>▶ Do not set the trigger weight too low.</p> <p>▶ Do not set the first stage travel and sear engagement too small.</p> |

14.8 Conversion single stage trigger to two-stage trigger

Adjustment using setting screw [L]. Turn the setting screw [L] to the left until the desired first stage travel is reached.

14.9 Trigger faults caused by incorrect adjustment

The trigger catches the cocking piston or the firing pin, but does not shoot when the trigger is actuated:

- ▶ Make sure that the safety catch is released.
- ☞ If the trigger stop setting screw [T] is screwed in too far by a few turns:
- ▶ Screw the trigger stop setting screw [T] to the left by a few turns until the cocking piston or the firing pin actuates again when the trigger is actuated.

The trigger does not catch the cocking piston or firing pin:

The setting screw [L] (first stage) is screwed in too far by a few turns.

- ▶ Screw the setting screw [L] to the left by a few turns, until the trigger catches the cocking lever or the firing pin again.
- ▶ Then set the desired first stage travel.
- ▶ Check that the tension spring [1] is undamaged and is hooked in correctly.

Setting screw [C], sear engagement, has been turned:

- ▶ Turn the setting screw [C] by approx. 1 turn to the left.
- ▶ Cock the weapon, turn the screw [C] to the right until the weapon discharges. Then turn back by 1/5 of a turn.

14.10 Basic adjustment of the trigger



NOTE!

This procedure is used to reset all settings on the trigger. With this starting setting, the trigger can then be individually adjusted again.

- ▶ Remove the action from the stock.
- ▶ Set the adjusting screw [T] so that the head of the screw is flush with the trigger housing surface [5].
- ▶ Set the adjusting screw [L] so that the trigger sear [7] is horizontal.
- ▶ Cock the action.
- ▶ Set the trigger using the relevant adjustment screws to give the individual settings desired.

15. Dry firing device

The safety catch can also be used as a dry firing device.

- ▶ Open the cocking lever and swing it slowly to the rear until a stop is felt.
- ▶ Push the safety catch in to „S“.
- ✓ Dry firing device is active.
- ▶ Close the cocking lever.
- ▶ Release the trigger.



NOTE!

The safety/dry firing device can only be actuated when the airgun is cocked.



NOTE!

The trigger function must be checked after every change. When the fault is eliminated, check the desired trigger values and reset them if necessary.

16. Compressed air cylinder

The compressed air rifle is fitted with an exchangeable compressed air cylinder [14]. The compressed air cylinder can be exchanged in both the full and empty condition. On delivery, the compressed air cylinder is not screwed in tightly. You should always use the covering cap to protect the thread on the compressed air cylinder from dust and damage.



CAUTION!

Only genuine ANSCHÜTZ compressed air cylinders (max. 200 bar) may be used! The use of third party products can result in very expensive repair costs to your air rifle and, in worst case scenario, can cause serious bodily injury.



NOTE!

Repairs on ANSCHÜTZ compressed air cylinders are not allowed due to the type approval. Non-observance will void the liability and warranty.



NOTE!

Since your safety is very important to ANSCHÜTZ, the original ANSCHÜTZ compressed air cartridges (max. 200 bar) are subjected to a very elaborate and expensive type of examination as well as an extensive and continuous inspection and approval, also during the entire manufacturing process. Please pay attention to the original TÜV quality seal on your compressed air cartridge. Please do not use compressed air cartridges that do not have this seal of approval! You can endanger yourself and others!

NOTE!



According to ISO 26262 the ANSCHÜTZ air cylinders order no.: 013357, order no.: 013358, order no.: 013359 and order no.: 011761 are safety and function relevant components of the ANSCHÜTZ Match air rifles. The use of non ANSCHÜTZ original compressed air cartridges can lead or contribute to a reduction of the functional safety and to malfunctions of the cartridge, which will void any warranty claims, goodwill and liability. Damage to the pressure regulator may also occur!

Pressure regulator after using an original ANSCHÜTZ compressed air cartridge:

Pressure regulator without damage, wear or other signs of wear, by following the operating instructions.



Destroyed pressure regulator after using a NON original ANSCHÜTZ compressed air cartridge:

Severe damage to the sealing ring, air filter and heavily worn metal parts.

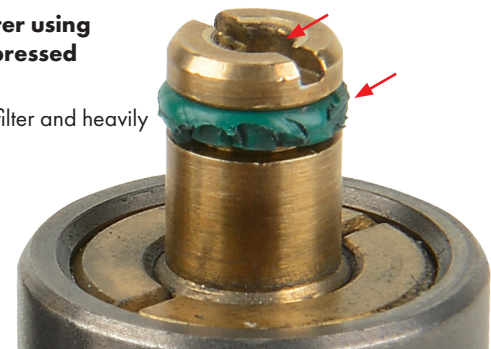

16.1 Screwing the compressed air cylinder in

- ▶ Fill the compressed air cylinder before using.
- ▶ Screw the compressed air cylinder slowly and carefully, hand-tight, into the thread on the sub-assembly carrier (to avoid damage).
- ⚠ *A perceptible resistance is felt shortly before the stop, and the valve opens automatically.*
- ▶ Screw the compressed air cylinder in, hand-tight, by approx. one more turn so that it rests tightly against the stop.

16.2 Releasing the compressed air cylinder

| | |
|---|---|
|  | NOTE! |
| | <p>ANSCHÜTZ recommends that the compressed air cylinders always be released when the compressed air rifle is not being used to protect the housing, valve, seals, springs and for safety reasons (no readiness to fire if there is no compressed air).</p> |

- ▶ Unscrew the compressed air cylinder by approx. just one turn. Turn only so far that no air comes out.
- ▶ Cock the rifle (see Chapter 12.1) and release the trigger. Repeat the procedure 3 times (to allow any remaining air to escape).
- ☞ The compressed air cylinder can then be unscrewed with no pressure on the O-ring.

| | |
|---|--|
|  | CAUTION! |
| | <p>Material damage! Damage to the O-ring if the air pressure is too high.</p> <ul style="list-style-type: none"> ▶ Never unscrew the compressed air cylinder so far that the compressed air can be heard coming out. |

16.3 Filling the compressed air cylinder

| | |
|---|---|
|  | NOTE! |
| | <p>ANSCHÜTZ recommends the proper use of eye protection when filling compressed air cylinders.</p> <ul style="list-style-type: none"> ▶ Check pressure indicators on pressure vessels regularly. ▶ Observe the pressure level in the compressed air system or pressure vessel. ▶ Do not exceed the maximum permissible filling pressure (caution: high temperatures lead to an increase in pressure). ▶ Do not make any changes to pressure indicators and other safety devices. ▶ Use only instruments which are designed for the existing pressure. ▶ Observe the color coding of the compressed air lines to avoid confusion with other supply lines (e.g. nitrogen or similar). ▶ Always shut off compressed air lines before disconnecting a device from the mains. ▶ Wear protective goggles when handling compressed air. ▶ Never direct compressed air at persons! Do not blow off clothing on the body! ▶ Observe the manufacturer's specifications and operating instructions. <p>When filling weapons, the following points must be observed in particular</p> <ul style="list-style-type: none"> ▶ Only use compressed air for filling. ▶ Filling operations must be carried out in compliance with the Technical Rules for Compressed Gases (TRG's). The maximum permissible filling pressure is 200 bar and must be strictly observed. ▶ Compressed air tanks must never be used or stored with more than the maximum filling. ▶ Leaky and/or otherwise dangerous, unsafe compressed air tanks must not be filled. These must be marked and safely emptied. |



NOTE!

Filling process / work sequence

- ▶ Only work with grease- and oil-free hands.
- ▶ Screw adapter onto refill bottle and tighten.
- ▶ Close the vent screw on the side.
- ▶ Then screw the compressed air cylinder onto the adapter and tighten hand-tight.
- ▶ Open the cylinder valve slowly and evenly (not abruptly) for about 5 seconds, then close the cylinder valve.
- ▶ Slowly open the side vent screw until residual air has flowed out.
- ▶ Remove the compressed air cylinder.



NOTE!

Behavior in case of accidents/first aid

- ▶ Switch off unit, shut off compressed air supply if necessary.
- ▶ Rescue injured persons.
- ▶ Provide first aid / initiate rescue chain.
- ▶ Secure accident site.



WARNING!

- ▶ Danger of explosion; explosive detonation.
- ▶ Risk of injury due to penetration of the compressed air into the body.
- ▶ Danger of flying objects etc. when cleaning with compressed air.
- ▶ Danger from working materials, e.g. liquids.



NOTE!

A complete fill (max. 200 bar) is adequate for approx. 200 shots (residual pressure approx. 65 bar). *Compressed air bottles can be obtained from firearms dealers. Refilling of compressed air bottles can also be carried out at firearms dealers or in special stores for diving equipment. *Not applicable with Junior cylinder.



NOTE!

Behavior in case of malfunctions

- ▶ Shut off the compressed air supply and secure it against use.
- ▶ If possible, release any residual pressure in the device.
- ▶ Inform supervisor.
- ▶ Faults may only be rectified by qualified personnel.



WARNING!

Only refilling bottles with a maximum pressure of 200 bar may be used! Only oil- and water-free compressed air may be used (DIN EN 12021)! Filling of the compressed air cylinders may only be carried out using the genuine ANSCHÜTZ refilling adapter (Item No.: 001521)! ANSCHÜTZ recommends the use of diving bottles for refilling the compressed air cylinders. When screwing on or off the compressed air cylinder or when refilling it, always stand side on in relation to the cylinder and ensure that no other person is in the vicinity of the end of the cylinder (where the manometer is positioned).

- ▶ Check all components that are associated with the filling procedure (refilling bottle, refilling adapter, compressed air cylinder) for damage.
- ▶ Screw the refilling adapter on to the refilling bottle.
- ▶ Screw the compressed air cylinder completely on to the refilling adapter.
- ▶ Tighten the knurled screw on the refilling adapter so that no air can escape.
- ▶ Open the bottle valve very slowly until you can no longer hear a flowing noise.
- ▶ Close the refilling bottle valve again after approx. 5 seconds filling time (the compressed air cylinder will heat up slightly).
- ▶ Vent the refilling adapter by releasing the knurled screw.
- ▶ Screw the knurled screw on the refilling adapter back in.
- ▶ Unscrew the compressed air cylinder and screw it into the rifle by hand.

WARNING!

In the trade, compressed air bottles with a permissible fill pressure of 300 bar are available, and these have the same filling spigot thread as compressed air bottles having a fill pressure of 200 bar!

If you use a compressed air bottle with 300 bar to fill the 200 bar compressed air cylinder, you must use a pressure reducer set to 200 bar!

It is not permissible to fill the compressed air cylinder to over the quoted maximum pressure! The regulations and rules for filling the compressed air cylinder must be observed!

17. Cheek piece

17.1 Removing the cheek piece

- ▶ Loosen the clamping screw [a].
- ▶ Remove cheek piece [1] from the retainer.
- ▶ Installation occurs in reverse order.
- ▶ Tighten the clamping screw [a] (torque 1.8 Nm)

17.2 Adjusting the cheek piece

- ▶ Clamping screw [a] (torque 1.8 Nm) = coarse elevation adjustment and rotation about the vertical axis.
- ▶ Knurled screw [b] = fine elevation adjustment (loosen clamping screw [c]).
- ▶ Clamping screw [c] (torque 2 Nm) = fixing of the fine elevation adjustment.
- ▶ Clamping screw [d] (torque 3 Nm) = rotation about the horizontal axis.
- ▶ Knurled screw [e] = lateral fine adjustment (loosen screws [f]).
- ▶ Clamping screws [f] (torque 1.8 Nm) = displacement of the cheek piece in the longitudinal direction.

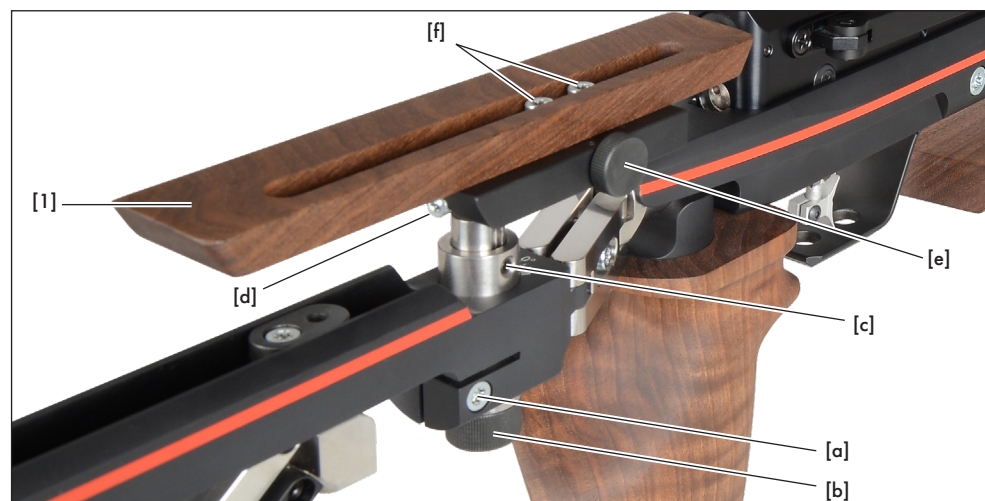

Fig. 11 Removing/adjusting the cheek piece

18. Butt plate

18.1 Removing the butt plate

- ▶ Loosen the clamping screw [a] (torque 3 Nm).
- ▶ Remove butt plate [25] from the retainer [x].
- ▶ Installation occurs in reverse order.

18.2 Adjusting the butt plate

- ▶ Clamping screws [a] (torque 2 Nm) = rotation about the vertical axis or removing the butt plate
- ▶ Clamping screws [b] (torque 2 Nm) = elevation adjustment and rotation about the vertical axis of the wing elements
- ▶ Clamping screws [c] (torque 2 Nm) = lateral tilting away of the wing elements and assembly or disassembly the ONE-Spacer [26]
- ▶ Clamping screw [d] (torque 1.8 Nm) = rotation of the ring elements
- ▶ Clamping screw [e] (torque 3 Nm) = tilting of the entire butt plate
- ▶ Angle stop screw [f] = defining and securing the tilting angle
- ▶ Clamping screw [g] (torque 2 Nm) = adjustment of the feedback rod

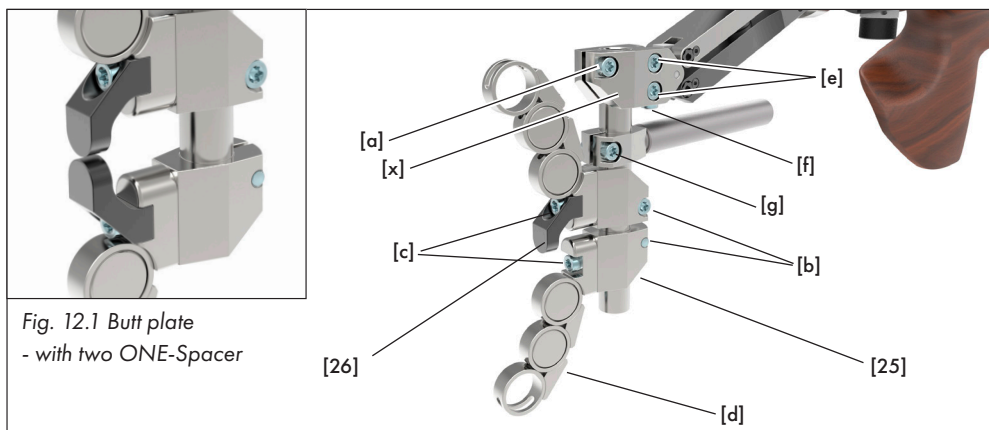

Fig. 12 Removing/installing the butt plate - with ONE-Spacer

18.3 Adjusting the butt plate for 3-position shooting

- ▶ Loosen the clamping screw [a] (torque 3 Nm)
- ▶ Remove the entire butt plate [25].
- ▶ Screw out the angle stop screw [f] at the bottom of the retainer [x]
- ▶ Screw in the angle stop screw [f] at the top of the retainer [x]
- ▶ Insert the entire butt plate [25] from the top into the retainer [x]. The bottom of the column must be below
- ▶ Tighten the clamping screw [a] (torque 3 Nm)

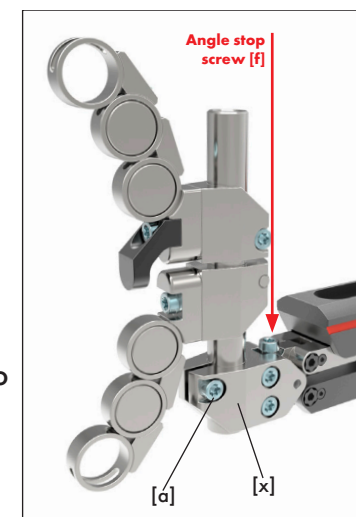

Fig. 13.2 Butt plate-3-position shooting - after conversion (with ONE-Spacer).
(See Fig. 12 - Butt plate before conversion to 3-position shooting adjustment)

18.4 Adjustment possibilities for the butt plate

The butt plate can be used in various diverse arrangements.

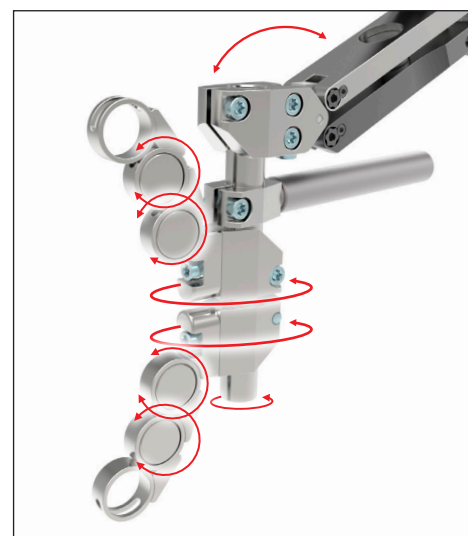

Fig. 13 Butt plate adjustment possibilities - without ONE-Spacer



Abb. 13.1 Butt plate adjustment possibilities - with two ONE-Spacer

18.5 Stock carrier

- ▶ Clamping screw [d] (torque 1.8 Nm) = angular adjustment of the stock carrier

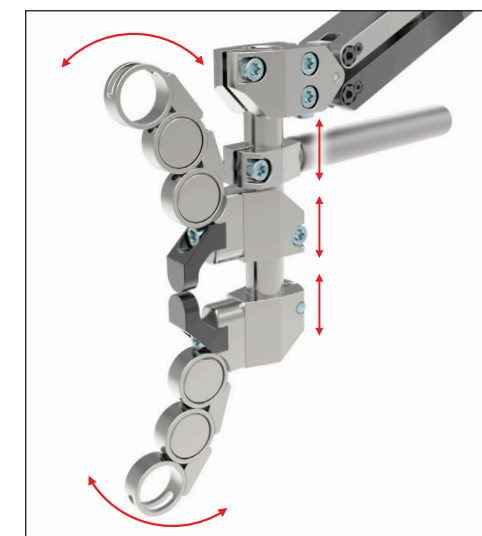
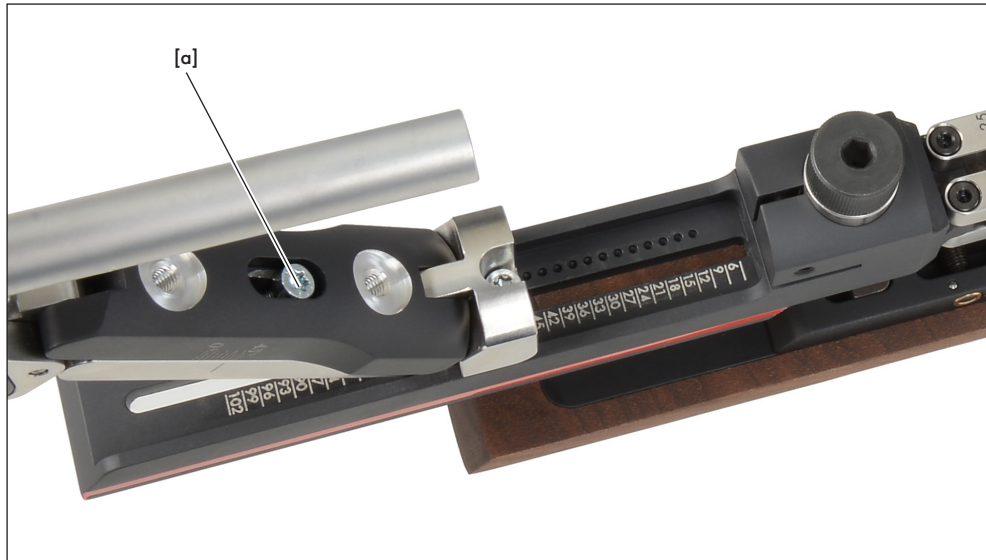

Fig. 14 Stock carrier

18.6 Length adjustment of the stock

- ▶ Clamping screws [a] + [b] (torque 3 Nm) = length adjustment of the stock carrier

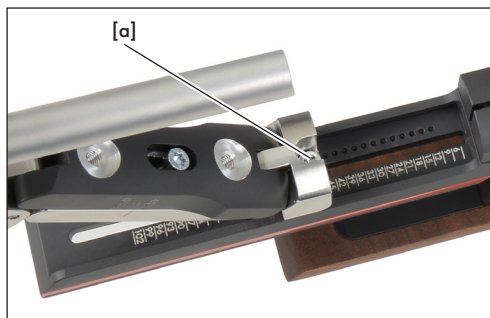

Fig. 15 Stock carrier, bottom



Fig. 16 Stock carrier, top

19. Stock adjustments

19.1 Fore-end raiser block

- ▶ Clamping screw [a] (torque 1 Nm) = displacement in the longitudinal direction, rotation about the horizontal axis
- ▶ Clamping screw [b] (torque 1.8 Nm) = elevation adjustment

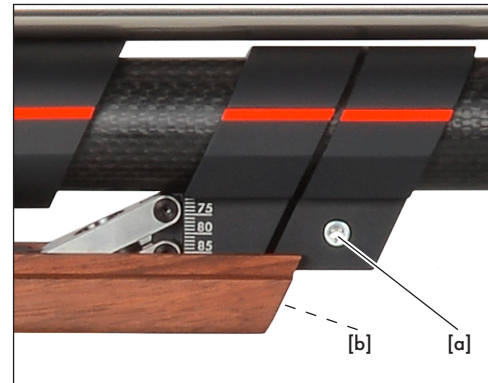

Fig. 17 Fore-end raiser block lateral

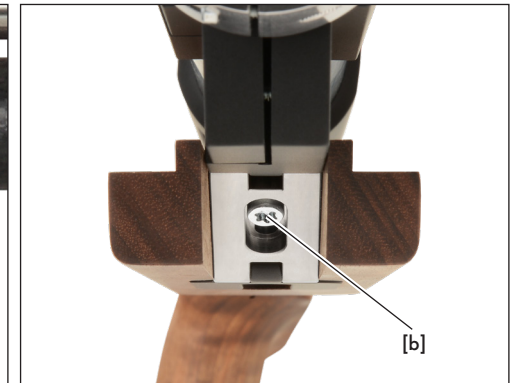

Fig. 18 Fore-end raiser block front

19.2 Offsetting the stock

- ▶ Clamping screw [a] (torque 1.8 Nm) = adjustment of the offset
- The adjustment range can be adjusted for right hand and left hand shooters by turning the clamping piece over 180°.

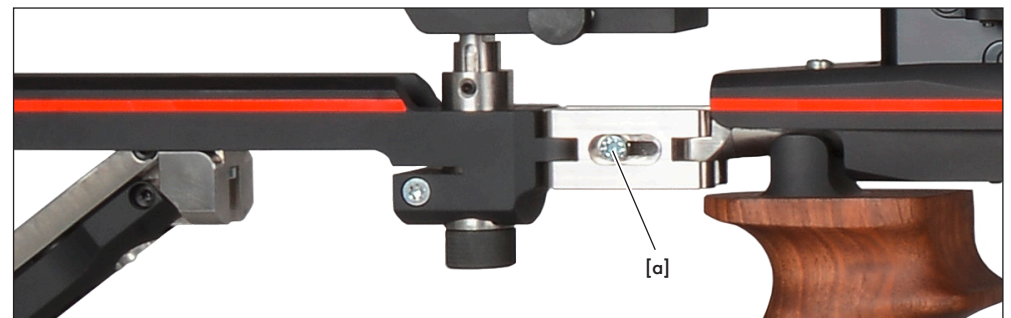

Fig. 19 Stock carrier offset

19.3 Grip adjustment

The rifle grip can be rotated and tilted and its position can be rotated and tilted in any direction and displaced in the longitudinal direction by releasing the grip fixing screw [a] (torque 3 Nm). The grip fixing screw [a] (torque 4 Nm) must be tightened again after adjusting the grip. The grip fixing screw [a] must be tightened now and again because settling may occur.

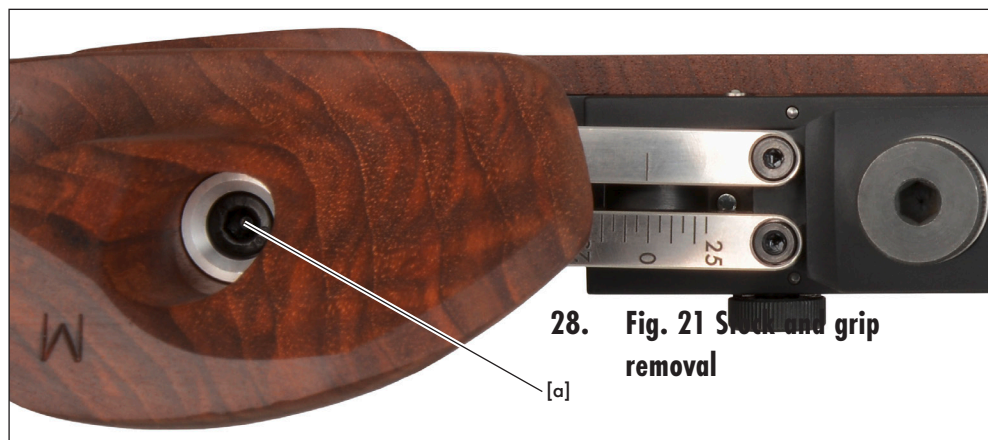

Fig. 20 Grip adjustment

20.1 Removing stock and grip

- ▶ Clamping screw [a] (torque 3 Nm) = releasing the stock and the grip.



Fig. 21 Stock and grip removal

20. Optical sights/rear sight (option)



NOTE!

Operating and maintenance instructions can be found in the individual manufacturer's documentation.

20.2 Mounting

The rear sight is slid on to the 11 mm wide V-block rails and locked in a suitable position using the 2 clamping screws (torque 1 Nm)..

20.3 Elevation and windage adjustment

The elevation and windage adjusting screws have click stops. The position of the aiming point is moved from click to click.

- Elevation when shooting high = turn rotary knob in „H“ direction
- Elevation when shooting low = turn rotary knob in „T“ direction
- Windage when shooting to the right = turn rotary knob in „R“ direction
- Windage when shooting to the left = turn rotary knob in „L“ direction

20.4 Zero adjustment

After the sights have been zeroed, the two adjusting screws can be set to the „0“ position.

- ▶ Release the set screws in the rotary knob.
- ▶ Position the rotary knobs to „0“ on the scale.
- ▶ Tighten the set screws in the rotary knob hand-tight.

⚠ The ANSCHÜTZ rear sight is aligned with zero clearance at the factory and does not require further adjustment. For this reason only the elevation and windage screws may be operated.

⚠ Do not turn the knobs beyond the stops at the end of the adjustment travel (the pre-tensioned threaded drive can be damaged).

21. Maintenance/cleaning

21.1 General

| | |
|---|--|
|  | WARNING! |
| | <p>Danger to life! Danger to life from loaded firearm.</p> <ul style="list-style-type: none"> ▶ Ensure that the rifle is unloaded before use or during maintenance and cleaning work. |

| | |
|---|--|
|  | CAUTION! |
| | <p>Injury and physical damage! Danger of injury or physical damage as a result of not removing the oil from the barrel and chamber.</p> <ul style="list-style-type: none"> ▶ Each time before shooting, any oil or foreign objects must be removed from the barrel and chamber. |

| | |
|--|--|
|  | CAUTION! |
| | <p>Always look out for any changes or damage that may occur to the rifle. In the event of a change or damage, the rifle must immediately be taken to an authorised gunsmith or sent to ANSCHÜTZ for inspection.</p> |

| | |
|---|--|
|  | NOTE! |
| | <p>The rifle should be protected from dust, sand, moisture, heat and damaging influences.</p> |

| | |
|---|--|
|  | NOTE! |
| | <p>A dry cloth is adequate to clean the aluminium stock. Under no circumstances should you use oil.</p> |

| | |
|---|--|
|  | NOTE! |
| | <p>To reduce the risk of breaking the stock during transport, ANSCHÜTZ recommends separating the barrelled action from the stock, especially during air travel.</p> |

| | |
|---|---|
|  | NOTE! |
| | <p>After each use of the rifle, apply a thin film of oil to the steel parts and thoroughly clean the barrel. When the rifle is transported from cold to warm rooms, condensation can form on the metal parts and inside the barrel. If this condensation is not quickly dried off, it can possibly lead to surface rust. No other aids (felt plugs, non-approved grease, etc.) should be used for cleaning the barrel. ANSCHÜTZ recommends the use of the Cleaning Kit 507 (Item No.: 001491) for cleaning</p> |

| | |
|---|--|
|  | NOTE! |
| | <p>When cleaning synthetic parts, use only oils that do not attack, damage or decompose the synthetics!</p> |

| | |
|---|---|
|  | NOTE! |
| | <p>Keep the stock dry, free of water and avoid condensation. Make sure that the stock does not come in contact with any solvents, cleaning agents or other substances.</p> <p>Do not stick any stickers or other objects on the stock. This can damage the stock surface.</p> |

After shooting

- Allow the firearm to warm up to room temperature with the action open.
- Carefully remove condensate from the outside parts.
- Rub the firearm (steel parts) down with a suitable gun oil.
- Maintain wooden parts with a suitable stock care product.

In the event of severe contamination (2000-3000 shots) or once a year in the course of inspection

- Clean the barrel with a bronze brush.
- ⚠ *Do not pull the brush backwards and forwards in the barrel.*
- Pull the cleaning wicks through the barrel in a dry condition a few times, until the final cleaning wick does not show any appreciable contamination.
- Rub the firearm (steel parts) down with an oily cloth.
- Take the rifle to a dealer/gunsmith for inspection.

| | |
|---|---|
|  | NOTE! |
| | <p>The rifle case / soft case should be cleaned regularly and any dust and fluff removed. Rifle cases and soft cases should have a smooth, dust-repellent lining.</p> <p>When not in use, the rifle case/soft case should always be left open to allow moisture to escape. Enclosing a desiccant can reduce the moisture content.</p> |

21.2 Maintenance intervals

Before shooting

- Carefully remove any oil from the rifle.
- ⚠ *The de-oiling of the rifle should be carried out at room temperature, as too many residues can be left in the barrel if it is very cold.*
- Fire around 10 shots to re-establish even shot performance (oil shots).

21.3 Trigger maintenance

- To avoid gumming, adhesion or soiling of the trigger parts, never wash out the inner parts of the trigger with a spray or oil. Keep the trigger dry and free from dust.
- ⚠ *No dirt, solvent residues, grease or unsuitable oils must get into the trigger assembly during maintenance of the rifle. ANSCHÜTZ recommends cleaning the rifle on its side or with the stock pointing upwards, which will prevent any adverse effects on the trigger assembly.*

25.1 Maintenance of the optical sights

NOTE!

The ANSCHÜTZ rear sight is a precision unit and consequently requires the utmost care when handling. Intensive care and maintenance guarantee perfect function. The rear sight must be protected from dust and dirt.

22. Troubleshooting

WARNING!

In the event of malfunctions (e.g. shots not discharged, etc.) the rifle must be unloaded, secured and taken without delay to a specialist dealer/gunsmith or sent to ANSCHÜTZ.

23. Technical Data (depending on model)

| | |
|------------------------|-------------------------------|
| Modellbeispiel | 9015 with stock ONE |
| Overall length | 990 – 1200 mm |
| Rifling | 420 mm |
| Barrel length | 592 mm |
| Barreled action length | 734 – 844 mm |
| Length of aiming | 620 – 897 mm |
| Length of pull | 300 – 420 mm |
| Length of stock | 755 – 857 mm |
| Version | Single loader |
| Weight approx. | 4,6 kg |
| Caliber | 4,5 mm |
| Propellant | Compressed air (200 bar max.) |

NOTE!

The technical data of similar models can be found at www.anschuetz-sport.com.

24. Disposal

The disposal of the rifle must be carried out and certified by a specialist dealer or gunsmith.

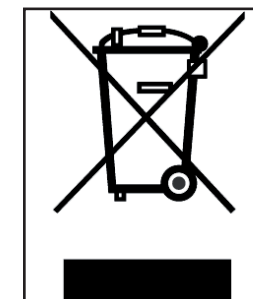

25. Miscellaneous

Additional information is available on the Internet at www.anschuetz-sport.com

News about this and other products is also provided by ANSCHÜTZ via the free-of-charge subscription to the ANSCHÜTZ Newsletter on the internet.

The original group for your rifle at 10 m is affixed to the CD case.

NOTE!

For hygienic reasons, please wash your hands wafter using the rifle, as there may be oil, grease or other contaminants on the rifle.

www.anschuetz-sport.com

26. Shooting Performance

The shooting precision of a rifle depends on several factors. One very important factor in this respect is the ammunition.

Not every barrel shoots with the same efficiency.

Considerable performance differences are apparent with each ammunition type. The sights are just as important. As such, only ANSCHÜTZ sights should be used and the ammunition matched to your rifle. Even ammunition from the same manufacturer and the same batch can, from one production run to another, and from one rifle to another, result in varying shooting performance and hitting accuracy. When the most suitable ammunition and sights have been selected, we can guarantee the excellent shooting performance of our weapons. See warranty card.

27. Warranty



EINFACH EINS WERDEN!

<<< WARRANTY >>>

1. Material:

This product has been released for sale after the product itself, its materials and individual components have been subjected to strict inspection, or the rifle has demonstrated its durability and function during test shooting. J.G. ANSCHÜTZ GmbH & Co. KG offers a full guarantee covering material and manufacturing faults (excluding broken stocks and springs) for a period of two years, provided that the fault can be shown to have been present at the time of handover of the product. No warranty claims will be accepted by J.G. ANSCHÜTZ GmbH & Co. KG for faults that are the result of improper use or unauthorised repairs. The item will either be repaired or replaced at our discretion. Claims for compensation - put forward for any legal reason whatsoever - are excluded.

2. Shooting Performance:

The purchaser undertakes to inform J.G. ANSCHÜTZ GmbH & Co. KG in writing of any faults detected in shooting performance within one month of purchase with the submission of their own shooting record. J.G. ANSCHÜTZ GmbH & Co. KG reserves the right to transfer the rifle to an independent agency for inspection (DEVA or a national ballistics office). Should such an agency confirm excellent shooting performance, J.G. ANSCHÜTZ GmbH & Co. KG is entitled to charge the purchaser the costs of the rifle inspection. The accepted warranties do not apply to rifle damage resulting from mechanical effects and improper use or care by the purchaser. The warranty is excluded if the rifle has been repaired or modified by unauthorised persons. Likewise, the warranty is cancelled when using reloaded ammunition or ammunition which is not CIP approved.

In the event of a warranty/damage claim please enclose this card, completed and signed by your dealer, with the product.

J.G. ANSCHÜTZ GmbH & Co. KG - Jagd- und Sportwaffenfabrik
Postfach 1128 · D-89001 Ulm/Germany · www.anschuetz-sport.com

Serial-No.:

Date:

Bought at:

INSTRUCTION MANUALS FOR FURTHER MODELS

To obtain further information and user manuals for our models, visit our website.
You can find them at www.anschuetz-sport.com



www.anschuetz-sport.com